

NOTES:
1. SEE SHEET 12 FOR LOCAL DETOUR ROUTE.

P:\PR55733\CHP\103793\Design\MOT\Sheets\MD001.dgn Design 12/3/2018 11:02:41 AM loucks

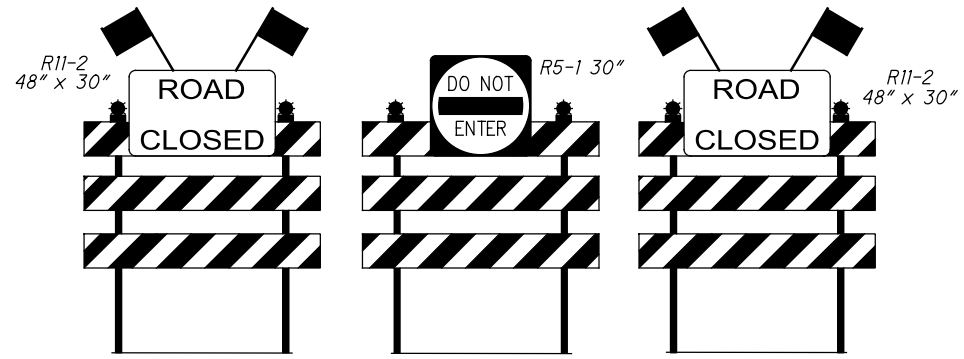

10' TYPE III BARRICADES (SOLID ACROSS STREET)
PER MT-101.60

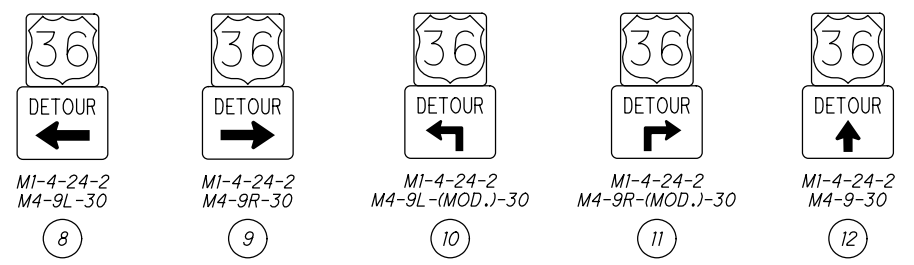
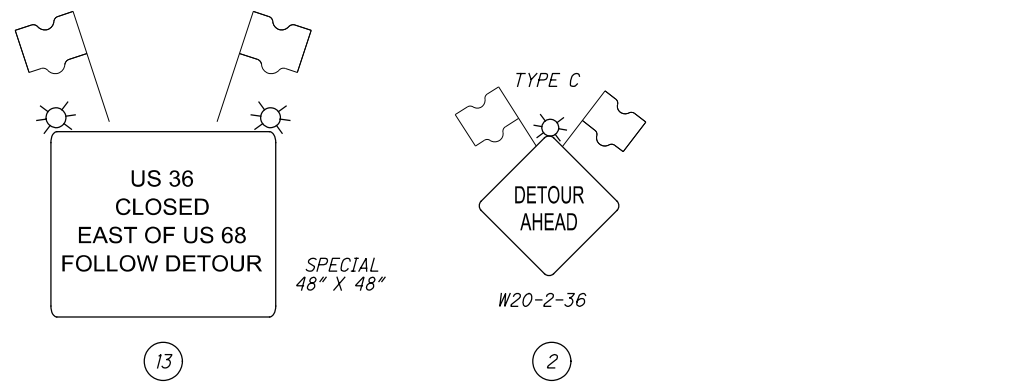
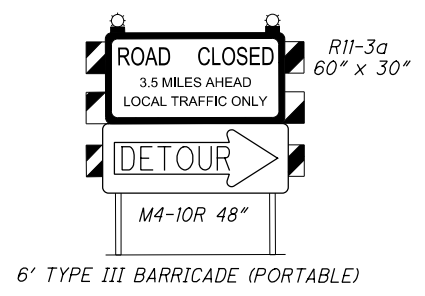

6' TYPE III BARRICADE (PORTABLE)



LEGEND

- TEMPORARY SIGN
- TYPE III BARRICADE WITH SIGNS
- WORK ZONE AREA
- DETOUR ROUTE

NOTES:

1. SEE SHEET 13 FOR LOCAL DETOUR ROUTE.

P:\PR55733\CHP\103793\Design\MOT\Sheets\MD002.dgn Design 12/3/2018 11:02:43 AM loucks

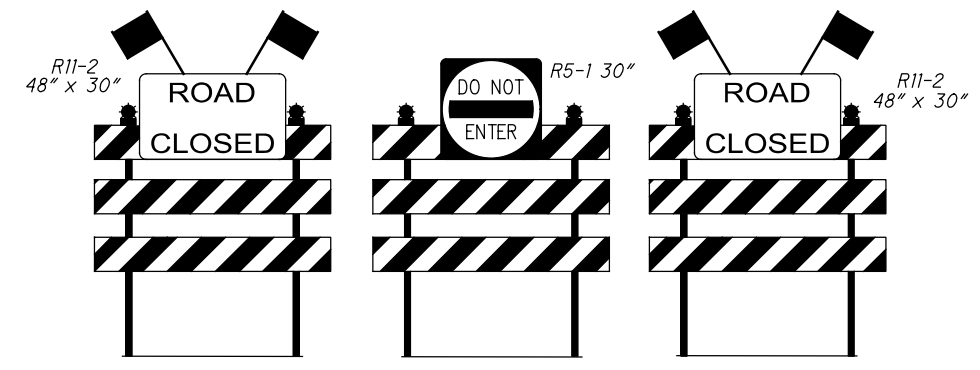
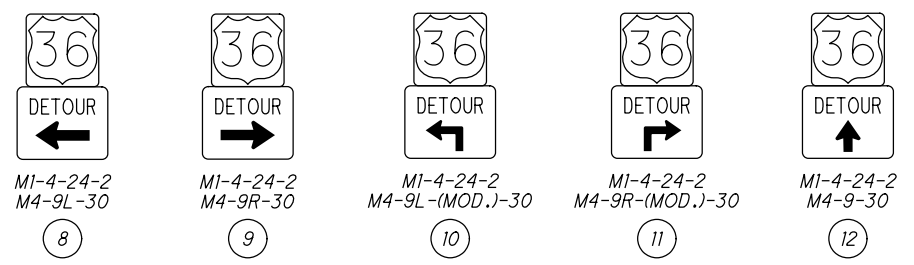
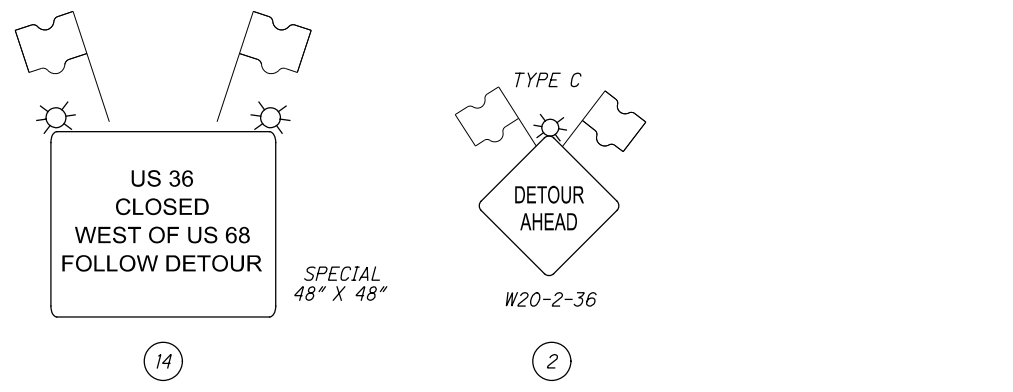

10' TYPE III BARRICADES (SOLID ACROSS STREET)
PER MT-101.60

A

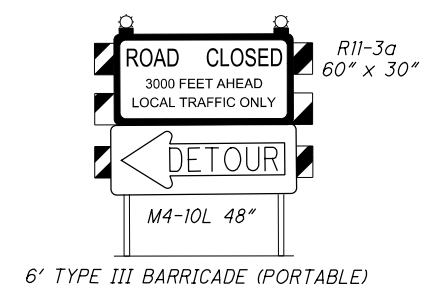

6' TYPE III BARRICADE (PORTABLE)

E



LEGEND

- ⊥ TEMPORARY SIGN
- ▬ TYPE III BARRICADE WITH SIGNS
- ▬ WORK ZONE AREA
- ← DETOUR ROUTE

NOTES:

1. SEE SHEET 14 FOR LOCAL DETOUR ROUTE.

P:\PR55733\CHP\103793\Design\M01\Sheets\MD003.dgn Design 12/3/2018 11:02:44 AM loucks

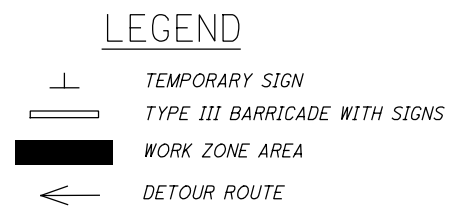
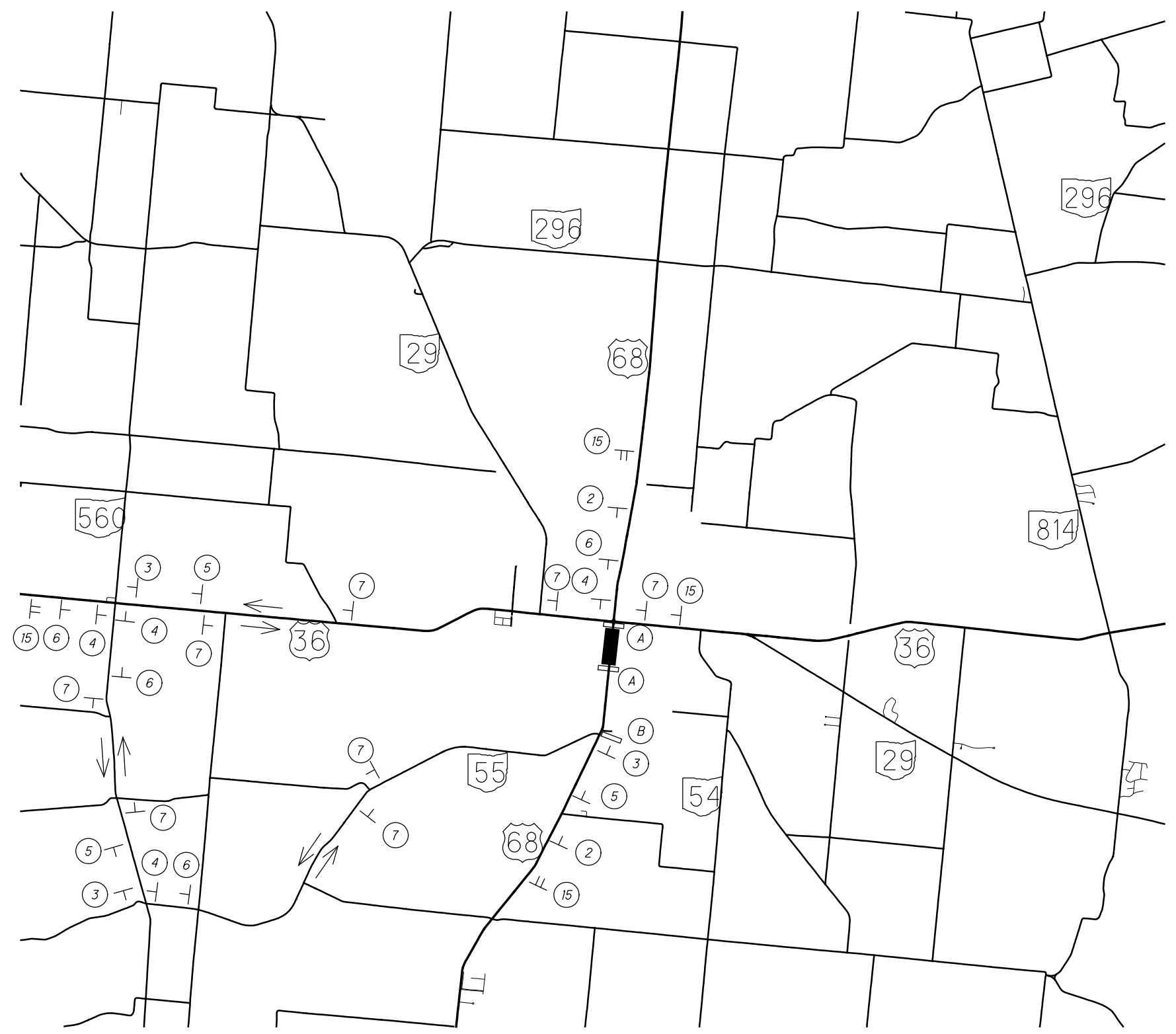
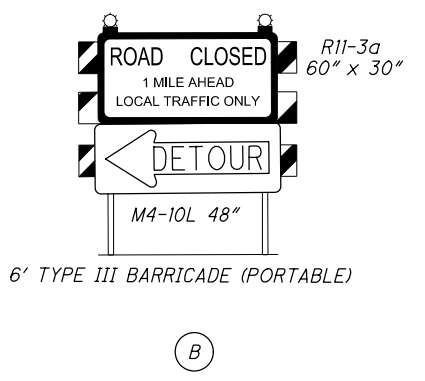
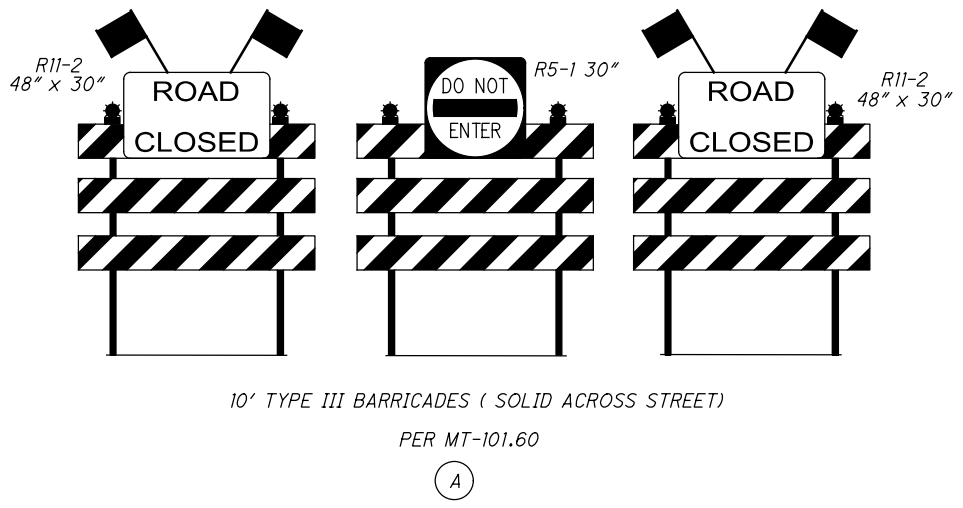
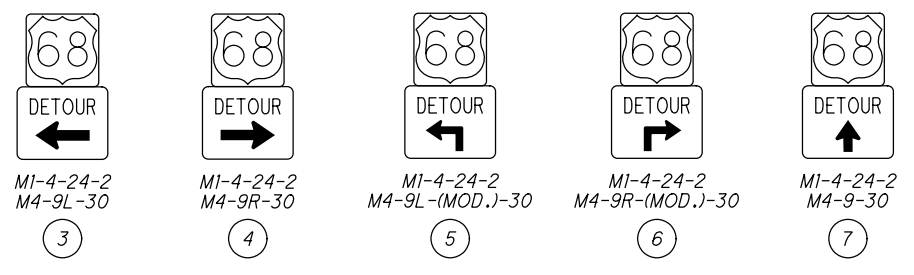
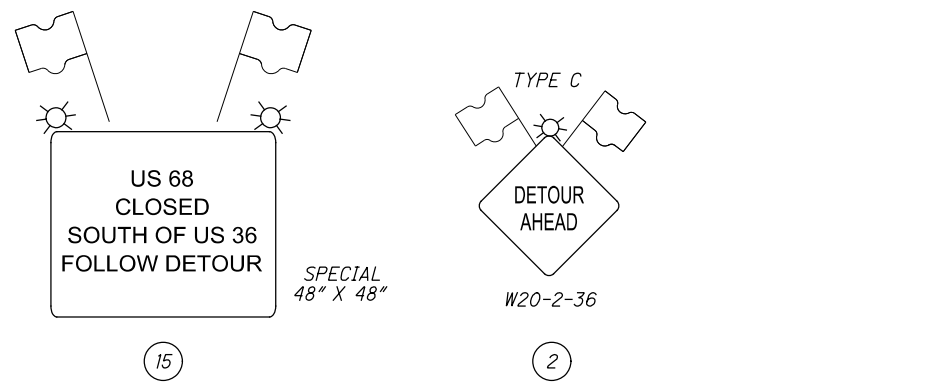

NOTES:
1. SEE SHEET 15 FOR LOCAL DETOUR ROUTE.

P:\PR55733\CHP\103793\Design\MOT\Sheets\MD004.dgn Design 12/3/2018 11:02:45 AM loucks

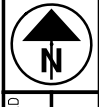

CALCULATED
BPT
CHECKED
EMW

MAINTENANCE OF TRAFFIC LOCAL DETOUR PLAN
N MAIN ST / US-68 NORTH LEG CLOSURE

CHP-US36-14.88

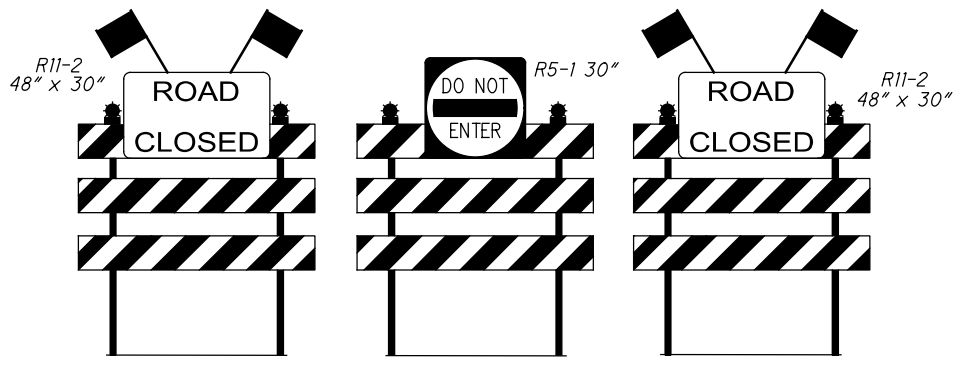
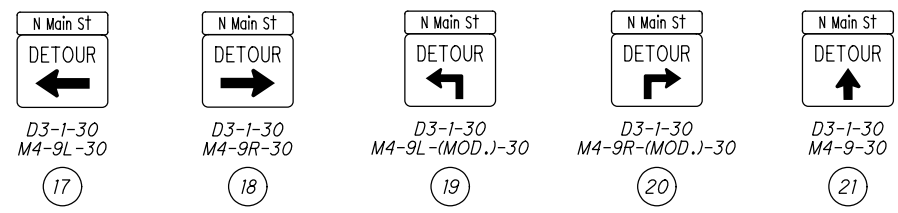
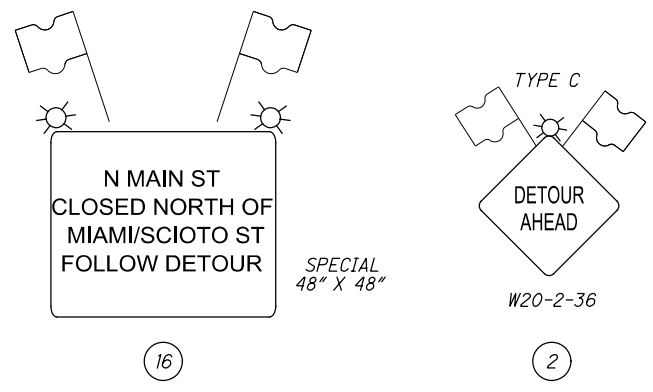

10' TYPE III BARRICADES (SOLID ACROSS STREET)
PER MT-101.60

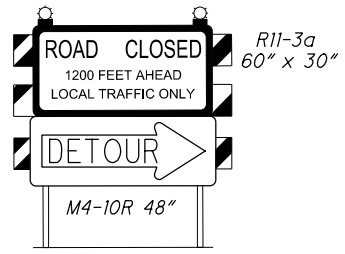

6' TYPE III BARRICADE (PORTABLE)

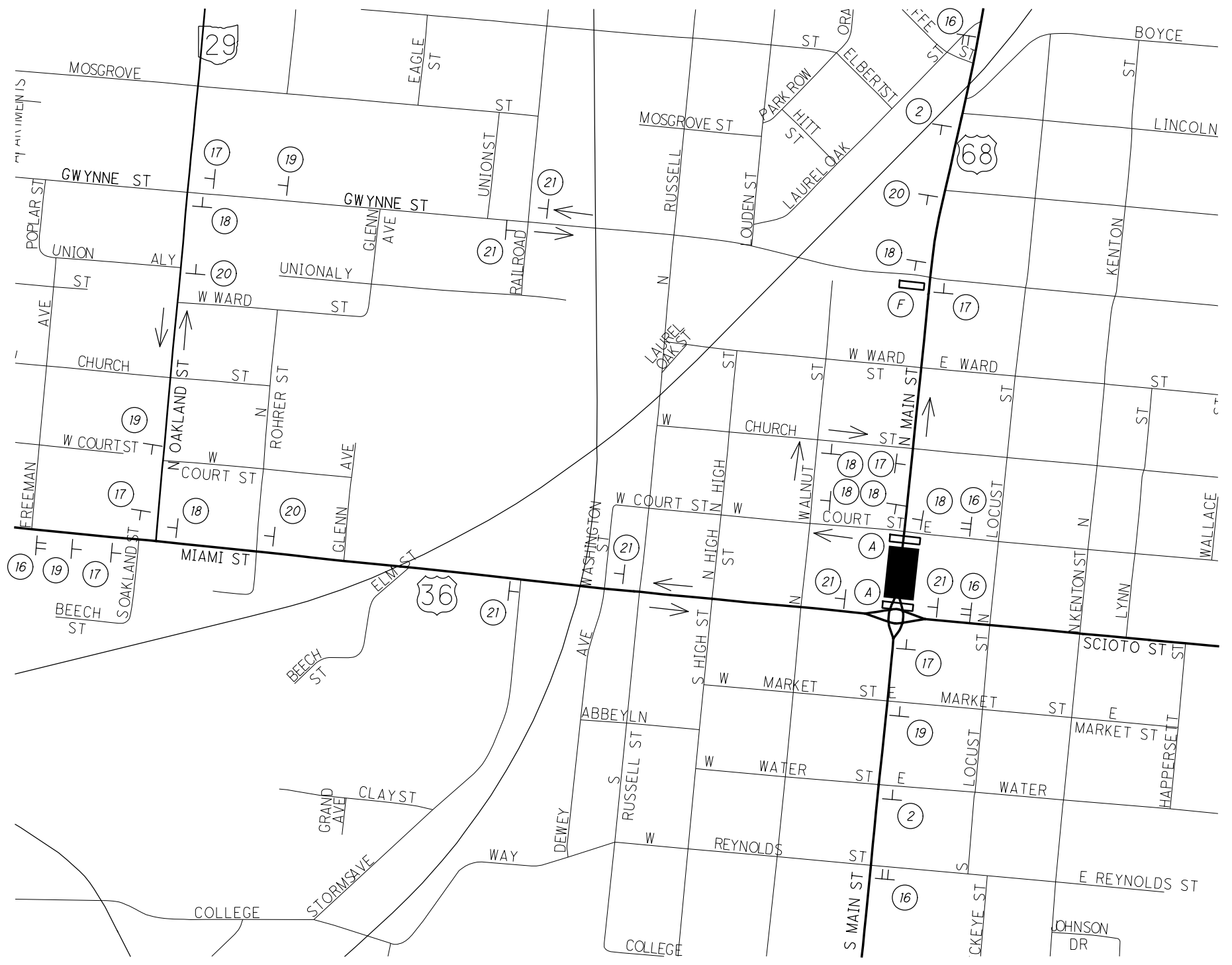

LEGEND

- ⊥ TEMPORARY SIGN
- ▬ TYPE III BARRICADE WITH SIGNS
- █ WORK ZONE AREA
- ← DETOUR ROUTE

NOTES:
1. SEE SHEET 8 FOR OFFICIAL DETOUR ROUTE.

P:\PR55733\CHP\103793\Design\MOT\Sheets\MD005.dgn Design 12/3/2018 11:02:47 AM loucks

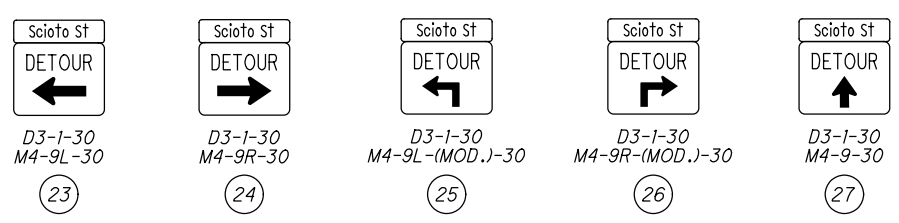
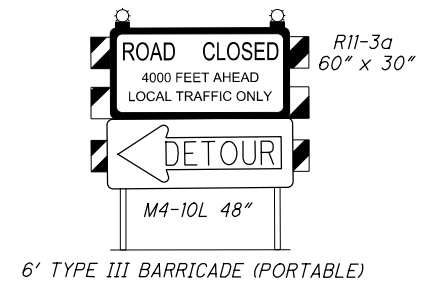
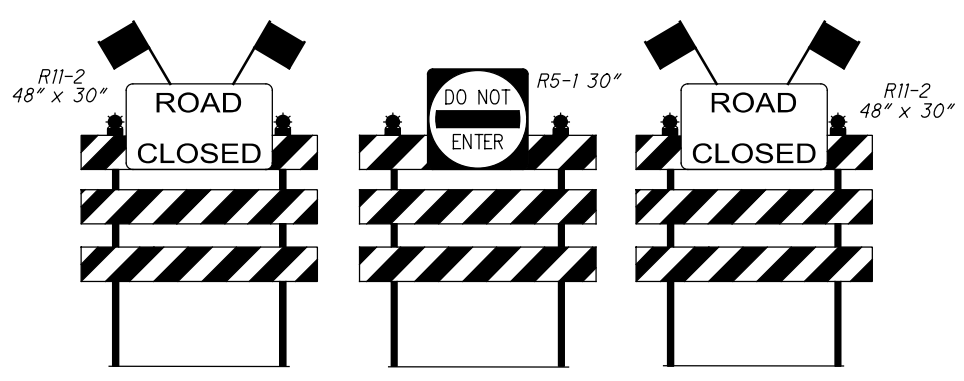
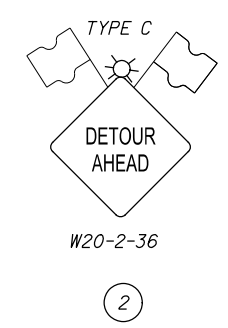
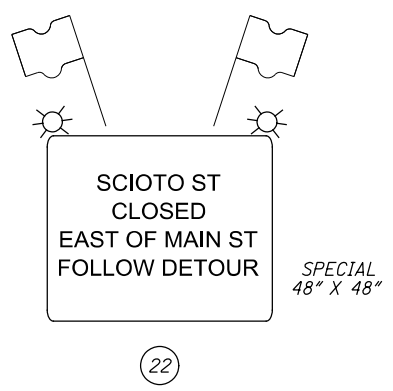
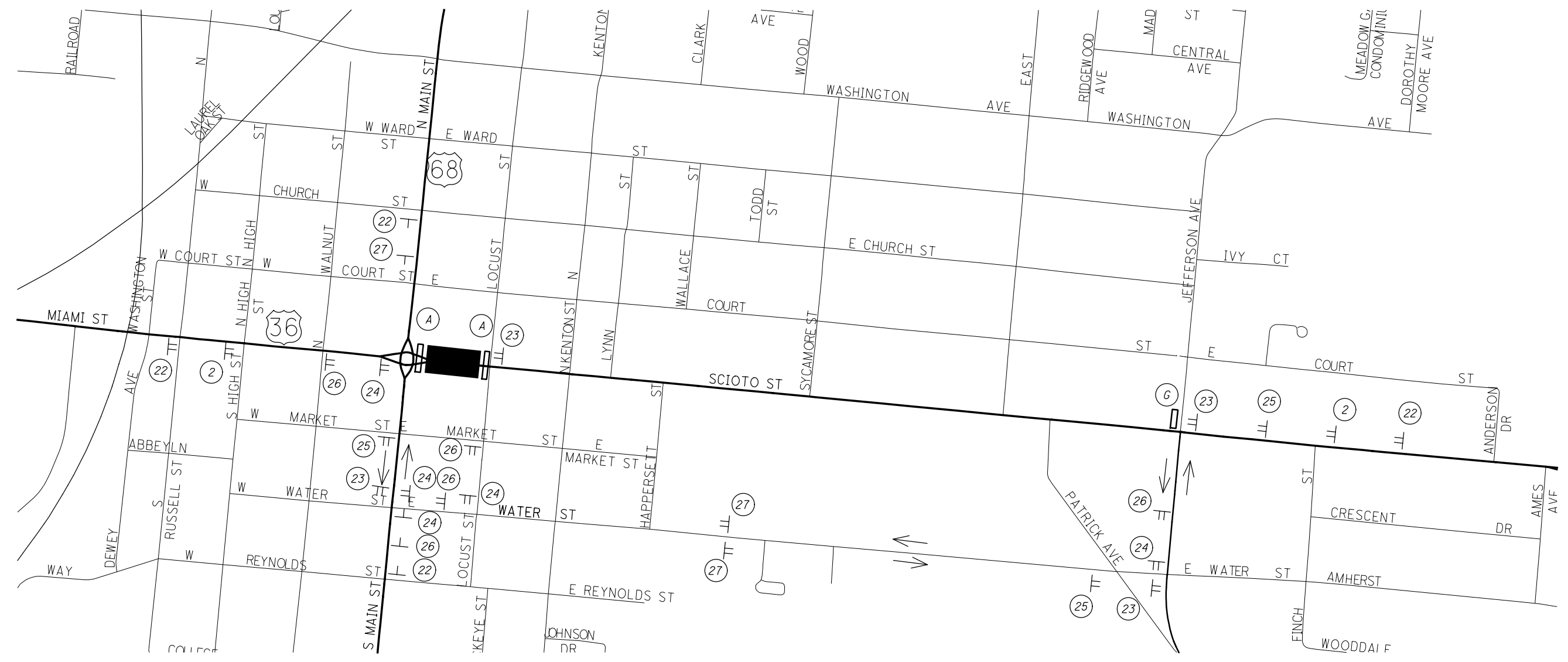

10' TYPE III BARRICADES (SOLID ACROSS STREET)
 PER MT-101.60

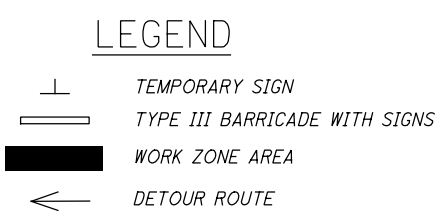

NOTES:
 1. SEE SHEET 9 FOR OFFICIAL DETOUR ROUTE.

P:\PR55733\CHP\103793\Design\MOT\Sheets\MD006.dgn Design 12/3/2018 11:02:48 AM loucks

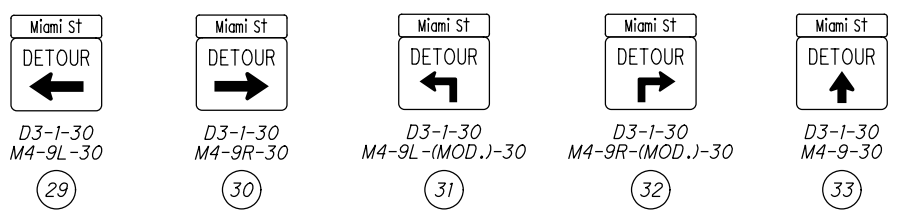
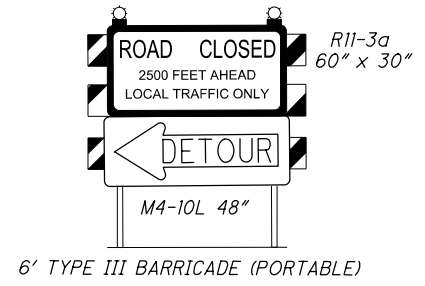
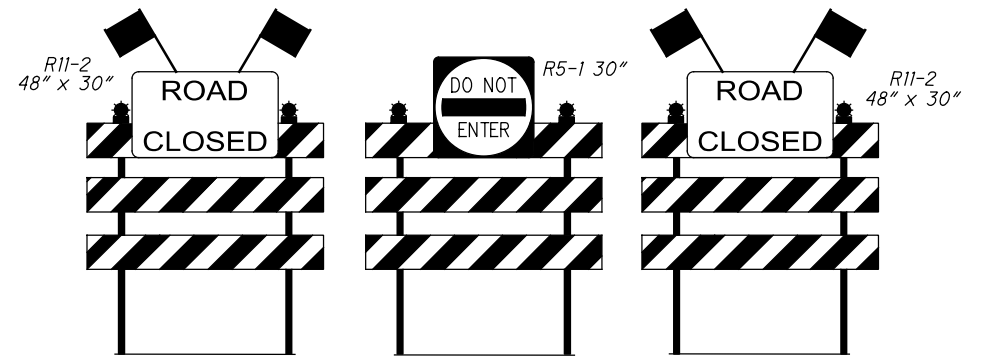
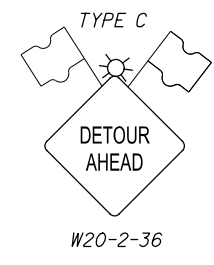
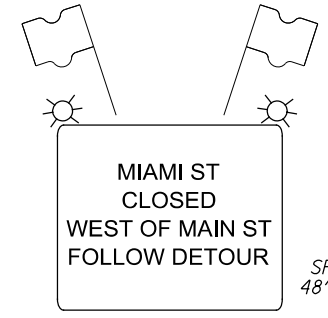

10' TYPE III BARRICADES (SOLID ACROSS STREET)
PER MT-101.60
(A)

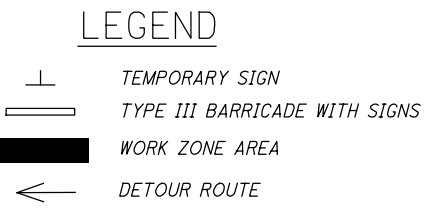

NOTES:
1. SEE SHEET 10 FOR OFFICIAL DETOUR ROUTE.

P:\PR55733\CHP\103793\Design\M0T\Sheets\MD007.dgn Design 12/3/2018 11:02:49 AM loucks

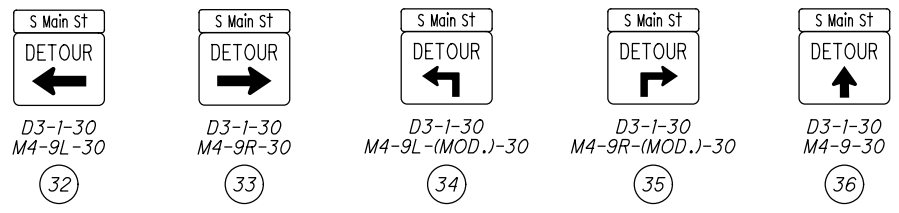
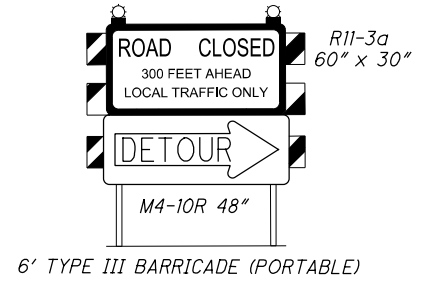
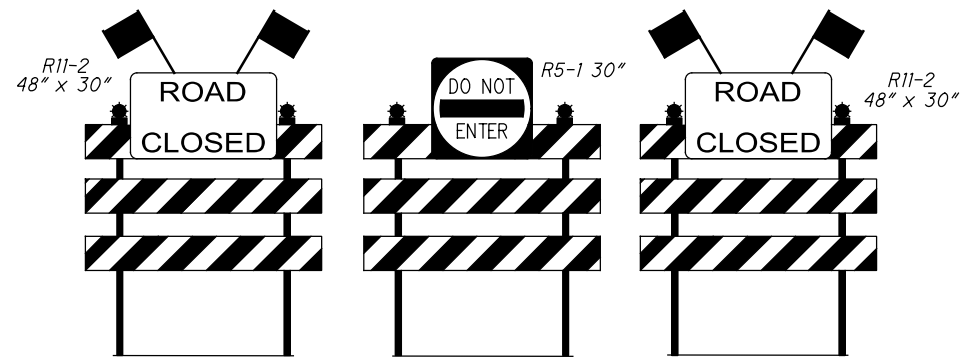
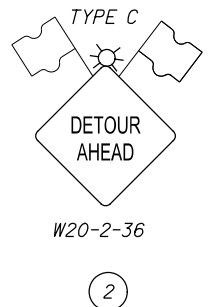
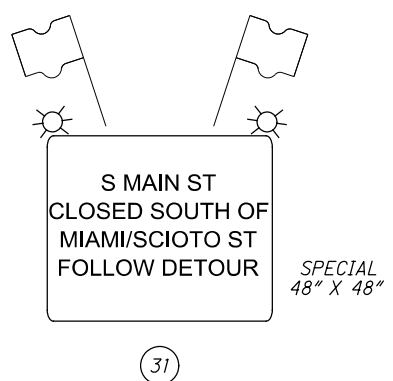

10' TYPE III BARRICADES (SOLID ACROSS STREET)
 PER MT-101.60
 (A)

6' TYPE III BARRICADE (PORTABLE)

LEGEND

- ⊥ TEMPORARY SIGN
- ▬ TYPE III BARRICADE WITH SIGNS
- WORK ZONE AREA
- ← DETOUR ROUTE

NOTES:
 1. SEE SHEET 11 FOR OFFICIAL DETOUR ROUTE.

P:\PR55733\CHP\103793\Design\M0T\Sheets\MD008.dgn Design 12/3/2018 11:02:51 AM loucks